

1/8 (row1 col1)

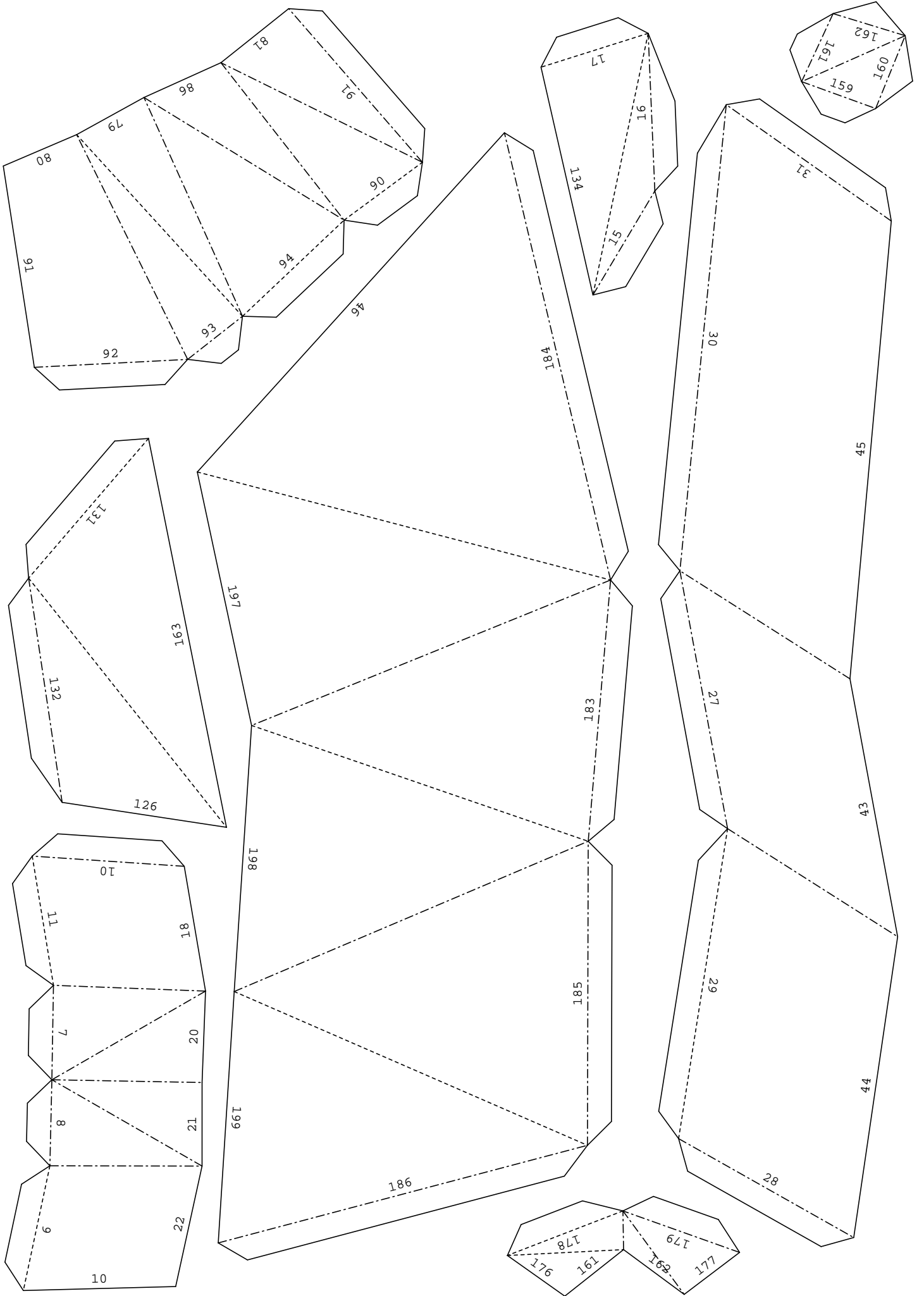

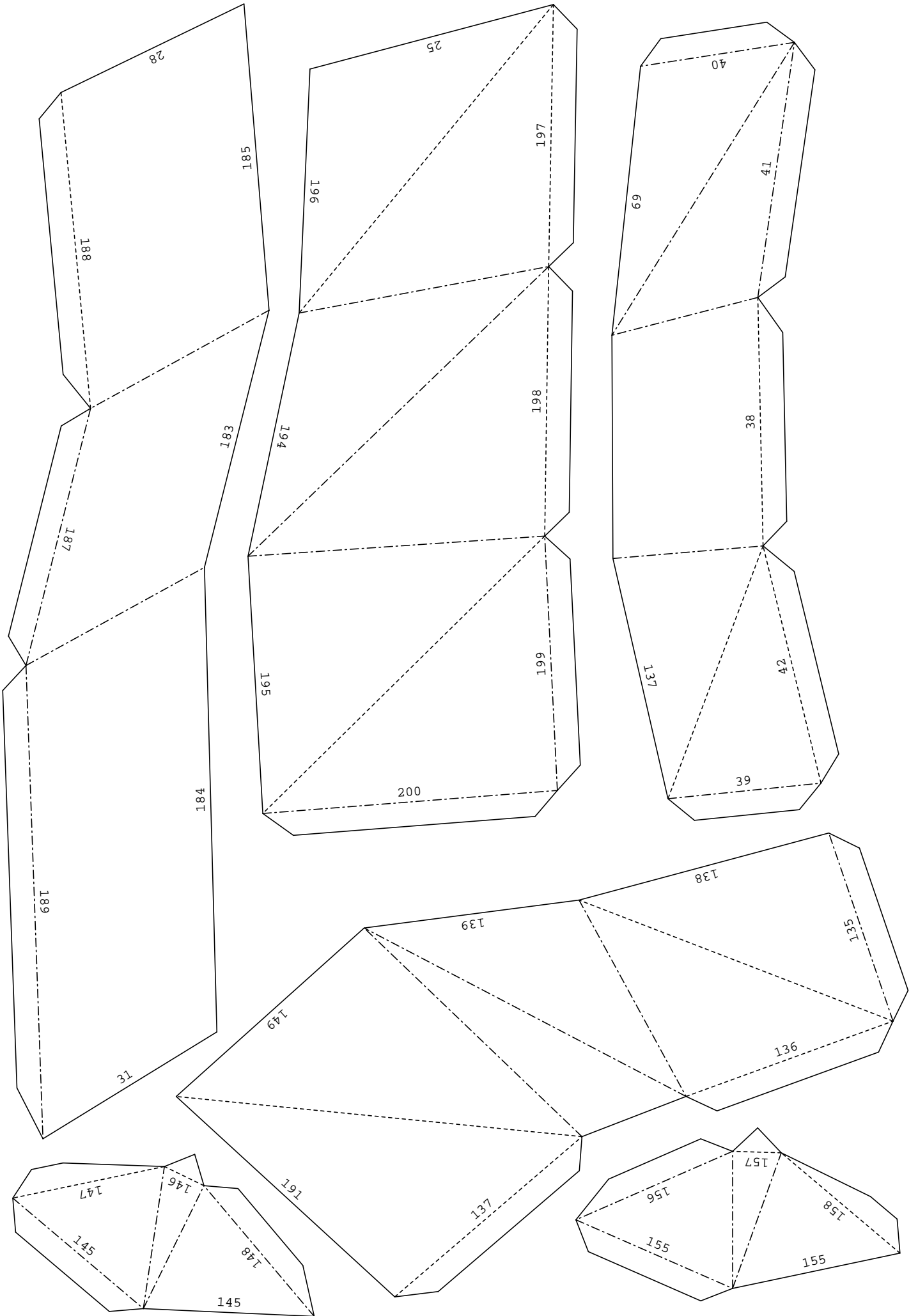

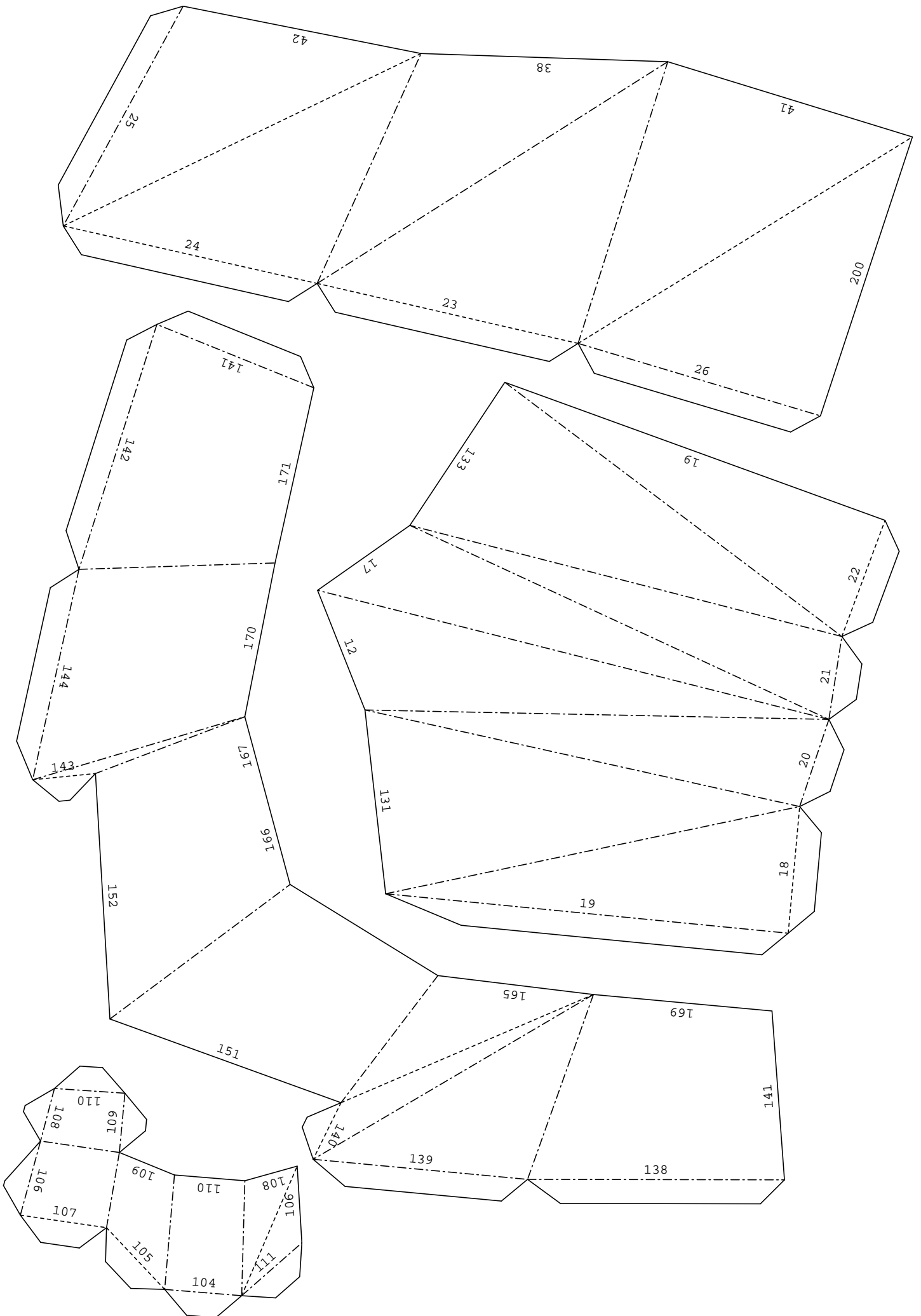

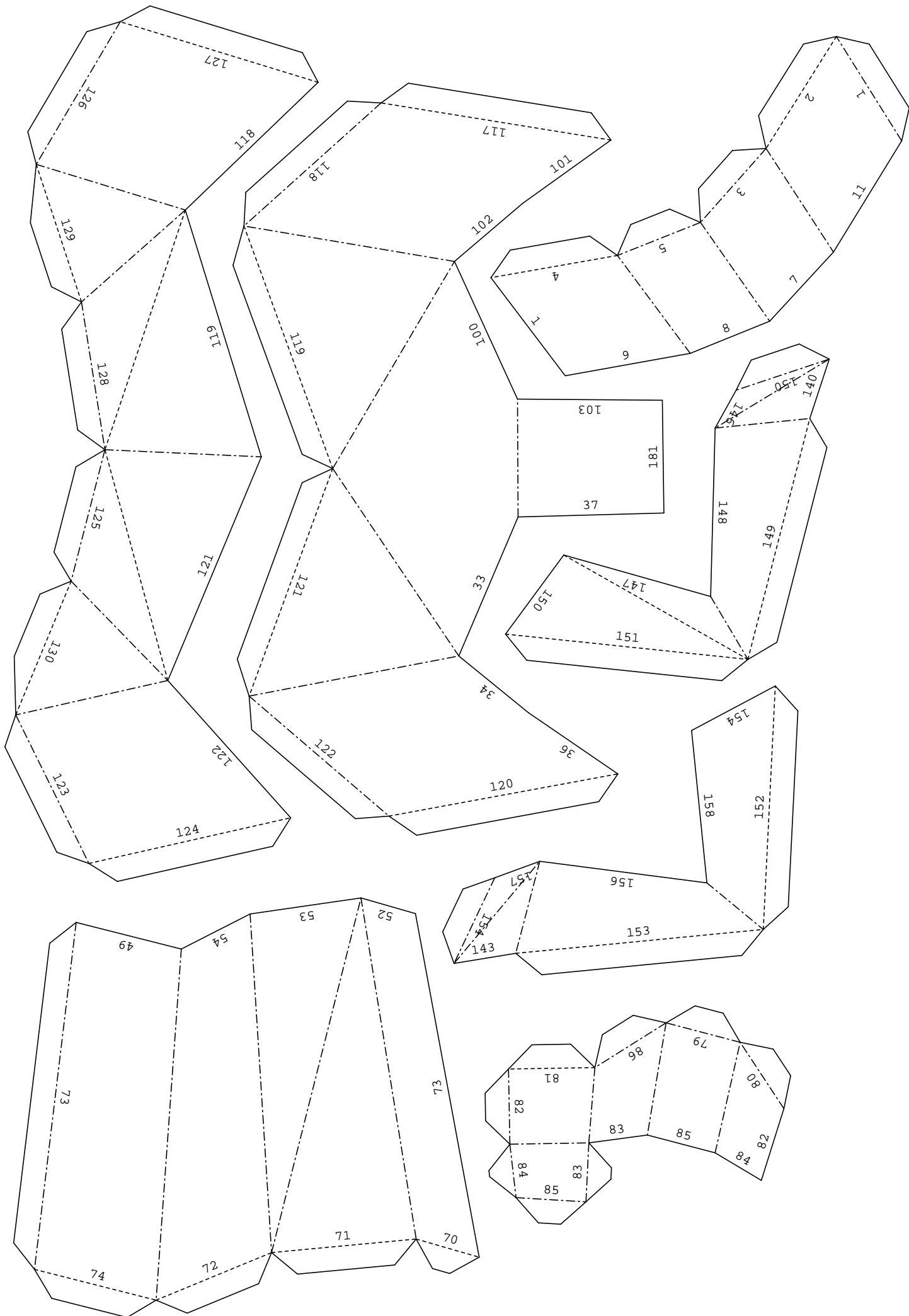

5/8 (row1 col5)

